

# 温度保险丝

Thermal-Link (ATCO)

CR系列 Series

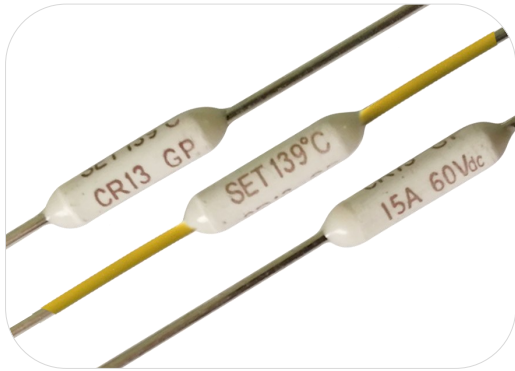

## 应用 Applications

- 灯具 Lamps
- 开关电源 Switched-Mode Power Supplies
- 家用电器 Home Electrical Appliances
- 变压器 Transformers
- 电机 Motors
- 电容器 Capacitors
- 防雷插座 Power Strips

## 特性 Features

- 动作温度精确 High Accuracy of Functioning Temp.
- 一次性动作而不可复位 Non-Resettable
- 环保型产品 RoHS & REACH Compliant

## 定制 Customization

- 温度 Temp.
- 引线长度 The Length of Lead Wires
- 可编带包装 Taping Packing Available
- 引线可采用绝缘线 Lead Wires can be Insulated

ATCO

ATCO

## 安规认证 Agency Approvals

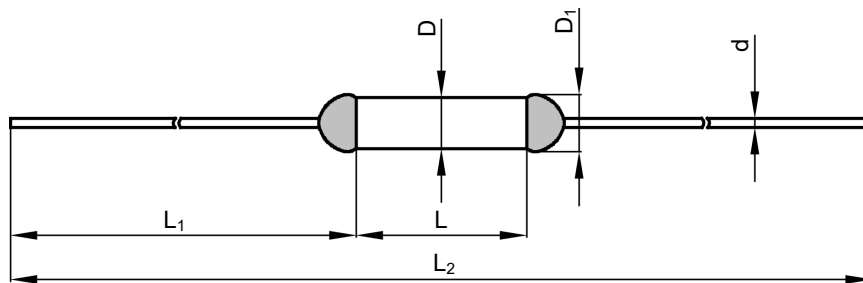

安规 Agency Mark	标准 Standards	认证号 No.
	UL 60691	E214712
	CAN-CSA-E60691	E214712
	EN 60691	R50415812

## 尺寸 Dimensions (mm)



L	L <sub>1</sub>	L <sub>2</sub>	D	D <sub>1</sub>	d
11.5 ± 0.5	34.0 ± 2.0	79.5 ± 3.0	3.3 ± 0.5	≤ 3.8	1.00 ± 0.05

技术参数 Specifications

型号 Model	额定动作 温度 $T_f$	熔断温度 Fusing Temp.	保持温度 $T_h$	极限温度 $T_m$	额定电流 $I_r$	额定电压 $U_r$	标称放电电流 $I_n$ 8 / 20 $\mu$ s (15 Times)	最大放电电流 $I_{max}$ 8 / 20 $\mu$ s (1 Time)				RoHS REACH
	(°C)	(°C)	(°C)	(°C)	(A)	(V)	(kA)	(kA)	UL	cUL	TUV	
CR13	139	135 ± 2	85	200	15	DC 60	6	12	●	●	●	●

备注 Note:

"●"表示产品已通过认证。Means certificated.

"○"表示产品未有认证。Means non-certificated.

产品温度时间曲线图 (仅供参考)

Product Temp.-Time Curve (For Reference Only)

温度保险丝在不同温度油浴中断开的温度时间曲线。  
The Temp.-Time Curve of Thermal-Link in different Temp. oil baths.

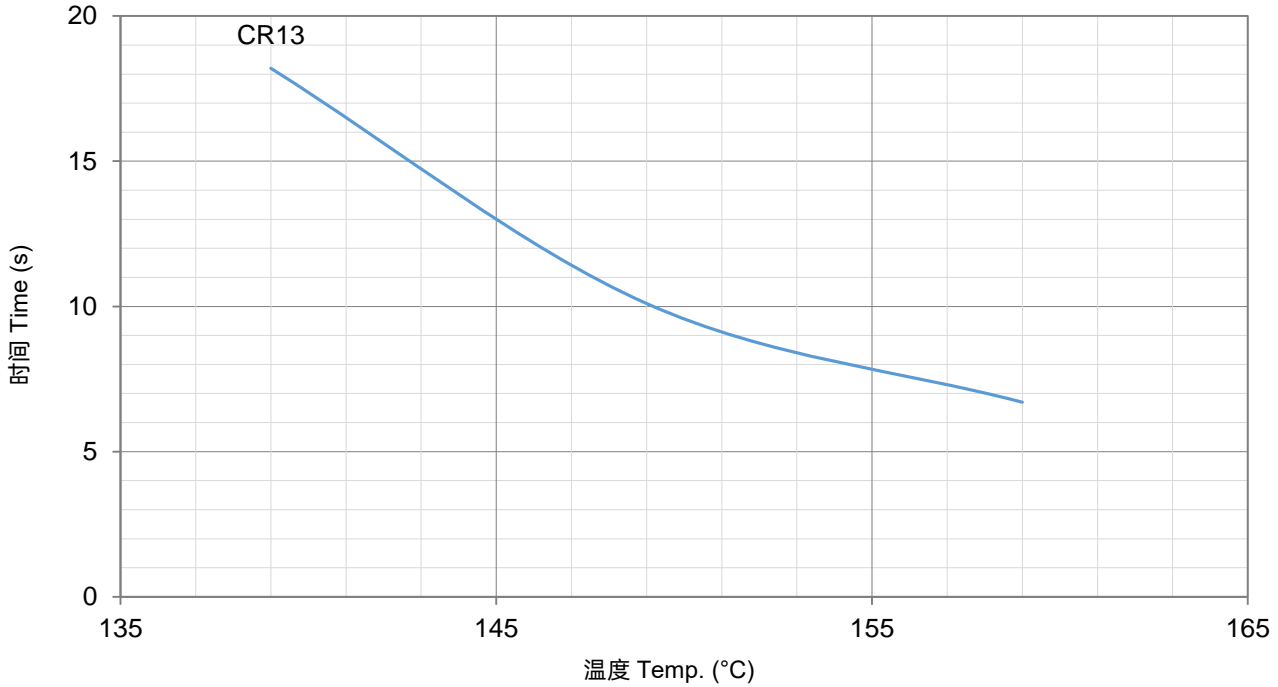

产品电流时间曲线图 (仅供参考)

Product Current-Time Curve (For Reference Only)

温度保险丝在室温 $25 \pm 2$  °C条件下, 测试数倍过载电流下的断开时间曲线。  
The Current-Time Curve shows functioning time at multi-times rated current at room temperature  $25 \pm 2$  °C.

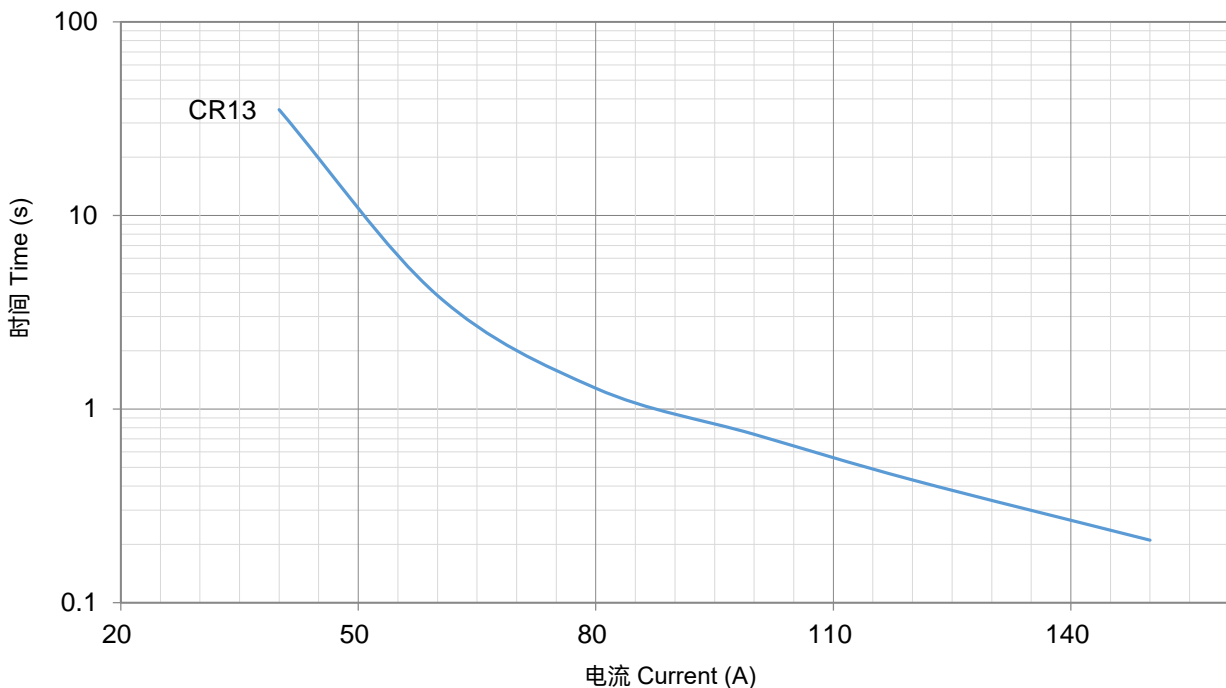

包装信息 Packaging Information

散装 Bulk

项目 Item	PE 袋 Bag	PE 袋 Bag	包装箱 Carton
尺寸 Dimensions (mm)	135 × 85	190 × 180	440 × 300 × 220
数量 Quantity (PCS)	100	1000	25000
毛重 Gross Weight (kg)			16.0 ± 10%

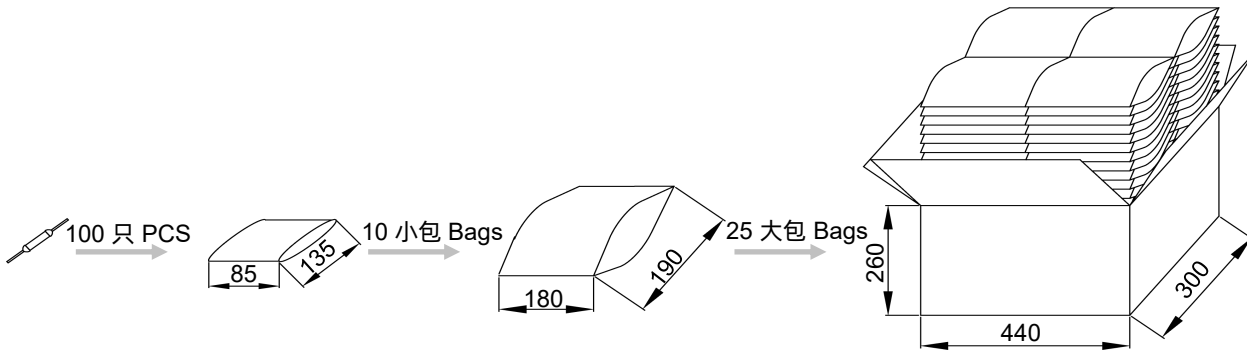

编带 Taping

项目 Item	卷轴 Scroll	盒子 Box	包装箱 Carton
尺寸 Dimensions (mm)	Φ 250 × 94	258 × 258 × 98	480 × 300 × 260
数量 Quantity (PCS)	2000	2000	8000
毛重 Gross Weight (kg)			12.0 ± 10%

